



DESCRIPTION

The ESD9D3.3/5.0/12 is designed to protect voltage sensitive components from ESD. Excellent clamping capability, low leakage, and fast response time provide best in class protection on designs that are exposed to ESD. Because of its small size, it is suited for use in cellular phones, MP3 players, digital cameras and many other portable applications where board space is at a premium.

The ESD9D3.3/5.0/12 is available in SOD-923 package

ORDERING INFORMATION

Package Type	Part Number
SOD-923	ESD9D3.3-5
	ESD9D5.0-5
	ESD9D12-5
Note	Package Q'ty/Reel 5=8,000pcs/Reel
AiT provides all RoHS Compliant Products	

FEATURES

- Small Body Outline Dimensions:
0.039" x 0.024" (1.0 mm x 0.60 mm)
- Low Body Height: 0.017" (0.43 mm) Max
- Stand-off Voltage: 3.3V ~ 12V
- Low Leakage
- Response Time is Typically <1 ns
- ESD Rating of Class 3 (>16kV) per Human Body Model
- IEC61000-4-2 Level 4 ESD Protection
- RoHS Compliance
- Available in SOD-923 package

APPLICATIONS

- Cellular phones audio
- MP3 players
- Digital cameras
- Portable applications
- mobile telephone

PIN DESCRIPTION





ABSOLUTE MAXIMUM RATINGS

IEC61000-4-2 (ESD)	Air discharge	±15kV
	Contact discharge	±8kV
ESD Voltage	Per Human Body Model	16kV
P _D , Total Power Dissipation on FR-5 Board ^{NOTE1}	@ T _A = 25°C	150Mw
T _J , T _{STG} , Junction and Storage Temperature Range		-55°C to 150°C
T _L , Lead Solder Temperature - Maximum (10 Second Duration)		260°C

Stresses above may cause permanent damage to the device. These are stress ratings only and functional operation of the device at these or any other conditions beyond those indicated in the Electrical Characteristics are not implied. Exposure to absolute maximum rating conditions for extended periods may affect device reliability.

NOTE1: FR-5 = 1.0 x 0.75 x 0.62 in.



ELECTRICAL PARAMETER

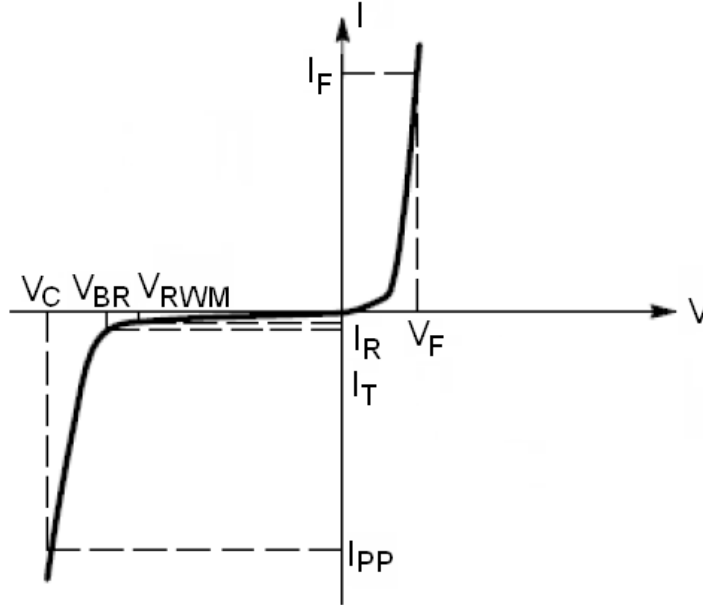

Uni-Directional TVS

$T_A = 25^\circ\text{C}$ unless otherwise noted

Symbol	Parameter
I_{PP}	Maximum Reverse Peak Pulse Current
V_C	Clamping Voltage @ I_{PP}
V_{RWM}	Working Peak Reverse Voltage
I_R	Maximum Reverse Leakage Current @ V_{RWM}
V_{BR}	Breakdown Voltage @ I_T
I_T	Test Current
I_F	Forward Current
V_F	Forward Voltage @ I_F
P_{PK}	Peak Power Dissipation
C	Max. Capacitance @ $V_R = 0$ and $f = 1\text{MHz}$



ELECTRICAL CHARACTERISTICS

T_A = 25°C unless otherwise specified. V_F = 0.9V Max. @ I_F = 10mA for all types

Part Number	V _{RWM} (V)	I _R (μ A) @ V _{RWM}	V _{BR} (V) @ I _T NOTE2	I _T	I _{PP} (A) NOTE3	V _C (V) @ Max I _{PP} NOTE3	P _{PK} (W) (8*20 μ s)	C(pF)
	MAX	MAX	MIN	mA	MAX	MAX	TYP	TYP
ESD9D3.3	3.3	2.5	5.0	1.0	9.8	10.4	102	80
ESD9D5.0	5.0	1.0	6.2	1.0	8.7	12.3	107	65
ESD9D12	12	1.0	13.5	1.0	5.9	23.7	140	30

Other voltage available upon request.

NOTE2: V_{BR} is measured with a pulse test current I_T at an ambient temperature of 25°C.

NOTE3: Surge current waveform per Figure 3.



TYPICAL CHARACTERISTICS

Figure 1. Typical Breakdown Voltage versus Temperature

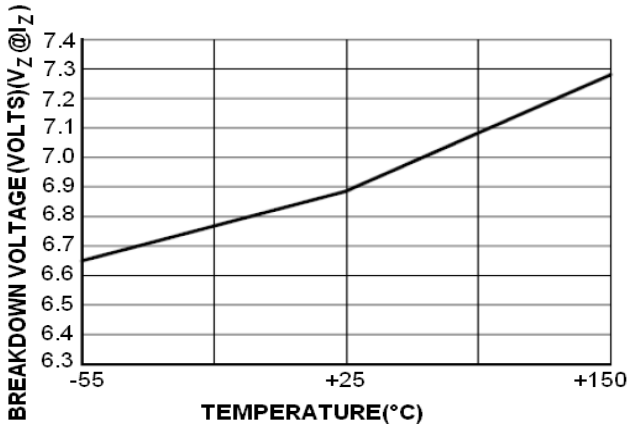

Figure 2. Typical Leakage Current versus Temperature

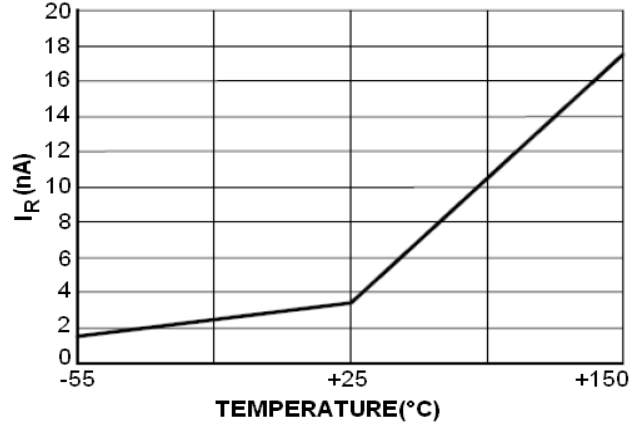

Figure 3. 8*20µs Pulse Waveform

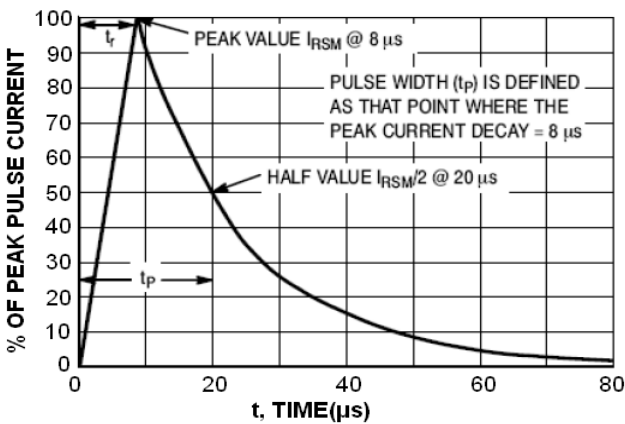

Figure 5. Positive 8kV contact per IEC 61000-4-2- ESD9D3.3/5.0/12

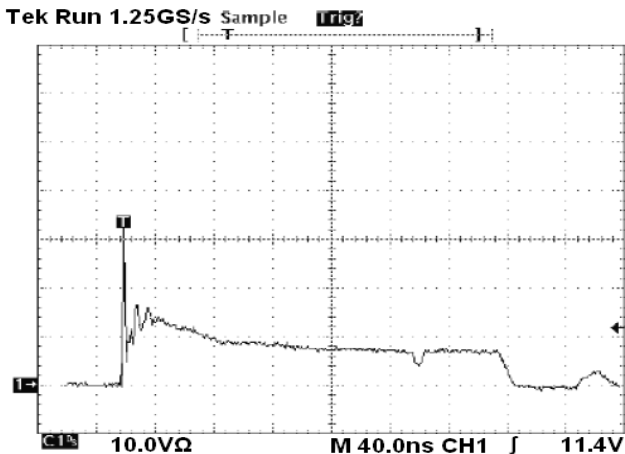

Figure 4. Normalized Junction Capacitance Voltage vs. Reverse Voltage

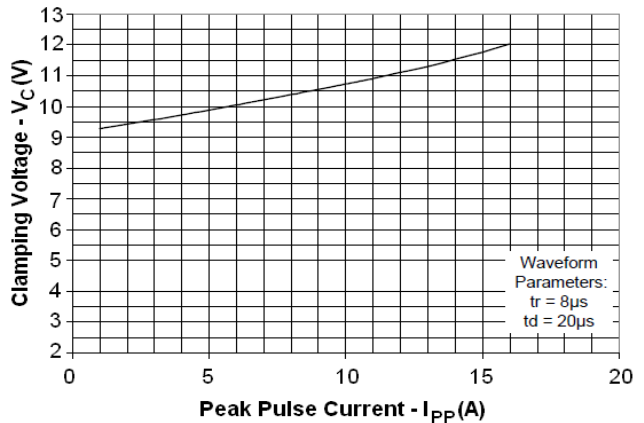
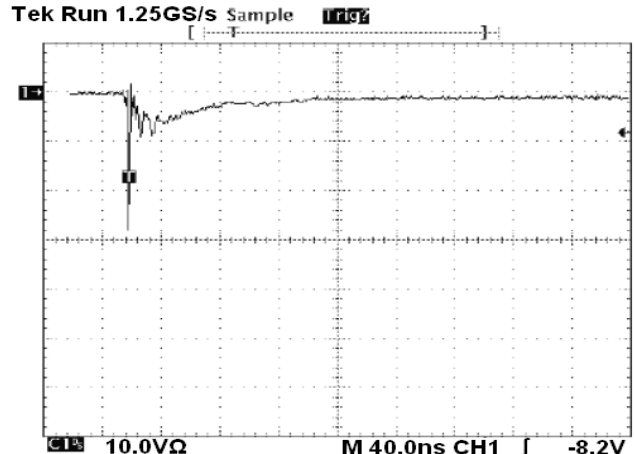

Figure 6. Negative 8kV contact per IEC 61000-4-2- ESD9D3.3/5.0/12





PACKAGE INFORMATION

Dimension in SOD-923 Package (Unit: mm)

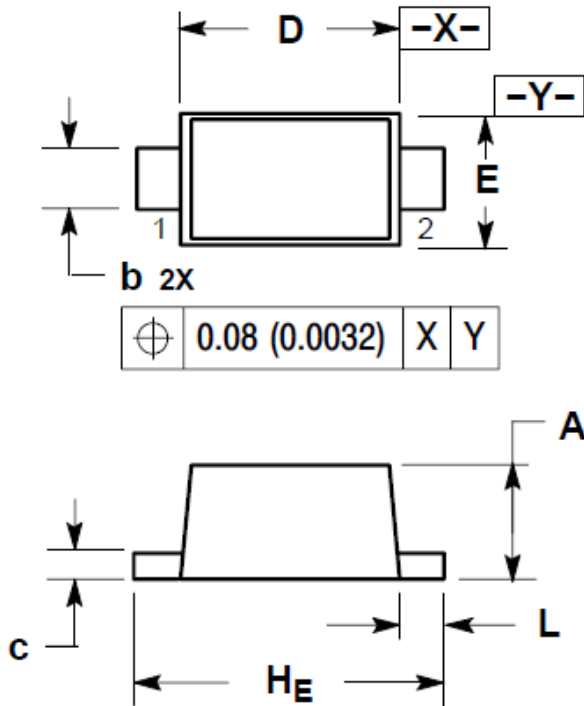

SOLDERING FOOTPRINT*

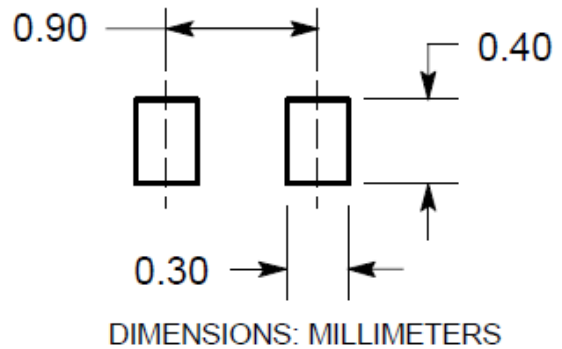

DIM	INCHES		MILLIMETERS	
	MIN	MAX	MIN	MAX
A	0.013	0.016	0.34	0.40
b	0.006	0.010	0.15	0.25
c	0.003	0.007	0.07	0.17
D	0.030	0.033	0.75	0.85
E	0.022	0.026	0.55	0.65
HE	0.037	0.041	0.95	1.05
L	0.002	0.006	0.05	0.15



IMPORTANT NOTICE

AiT Semiconductor Inc. (AiT) reserves the right to make changes to any its product, specifications, to discontinue any integrated circuit product or service without notice, and advises its customers to obtain the latest version of relevant information to verify, before placing orders, that the information being relied on is current.

AiT Semiconductor Inc.'s integrated circuit products are not designed, intended, authorized, or warranted to be suitable for use in life support applications, devices or systems or other critical applications. Use of AiT products in such applications is understood to be fully at the risk of the customer. As used herein may involve potential risks of death, personal injury, or severe property, or environmental damage. In order to minimize risks associated with the customer's applications, the customer should provide adequate design and operating safeguards.

AiT Semiconductor Inc. assumes no liability to customer product design or application support. AiT warrants the performance of its products of the specifications applicable at the time of sale.