



DESCRIPTION

The CRS08 is available in SOD-123FL Package Type

FEATURES

- Metal silicon junction, majority carrier conduction
- For surface mounted applications
- Low power loss, high efficiency
- High forward surge current capability
- For use in low voltage, high frequency inverters, free wheeling, and polarity protection applications
- Available in SOD-123FL Package

ORDERING INFORMATION

Package Type	Part Number
SOD-123FL	CRS08
Note	SPQ: 3,000pcs/Reel
AiT provides all RoHS Compliant Products	

MECHANICAL DATA

Case: SOD-123FL

Terminals: Solderable per MIL-STD-750,
Method 2026

Approx. Weight: 15mg 0.00048oz

PIN DESCRIPTION





ABSOLUTE MAXIMUM RATINGS AND ELECTRICAL CHARACTERISTICS

Ratings at 25°C ambient temperature unless otherwise specified. Single phase, half wave, 60Hz resistive or inductive load, for capacitive load, derate by 20 %

Parameter	Symbol	CRS08	Unit
Maximum Repetitive Peak Reverse Voltage	V_{RRM}	30	V
Maximum RMS voltage	V_{RMS}	21	V
Maximum DC Blocking Voltage	V_{DC}	30	V
Maximum Average Forward Rectified Current	$I_{F(AV)}$	1.5	A
Peak Forward Surge Current, 8.3ms Single Half Sine-wave Superimposed on Rated Load (JEDEC method)	I_{FSM}	50	A
Max Instantaneous Forward Voltage at 1.5A	V_F	0.55	V
Maximum DC Reverse Current at Rated DC Reverse Voltage	I_R	0.5 5	mA
Typical Junction Capacitance ^{NOTE1}	C_j	220	pF
Typical Thermal Resistance ^{NOTE2}	$R_{\theta JA}$	80	°C/W
Operating Junction Temperature Range	T_J	-55-+125	°C
Storage Temperature Range	T_{STG}	-55-+150	°C

NOTE1: Measured at 1MHz and applied reverse voltage of 4 V D.C.

NOTE2: P.C.B. mounted with 0.2 X 0.2" (5 X 5 mm) copper pad areas.



TYPICAL CHARACTERISTICS

Figure 1. Forward Current Derating Curve

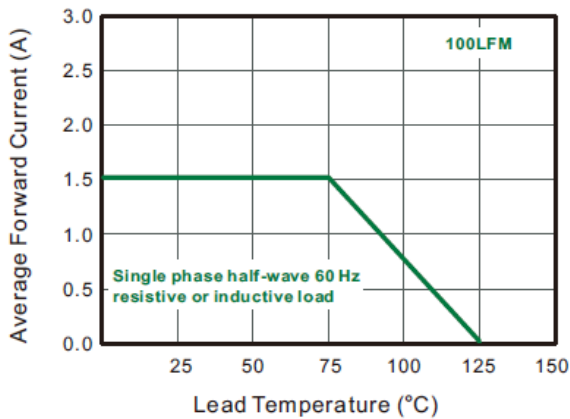

Figure 2. Typical Reverse Characteristics

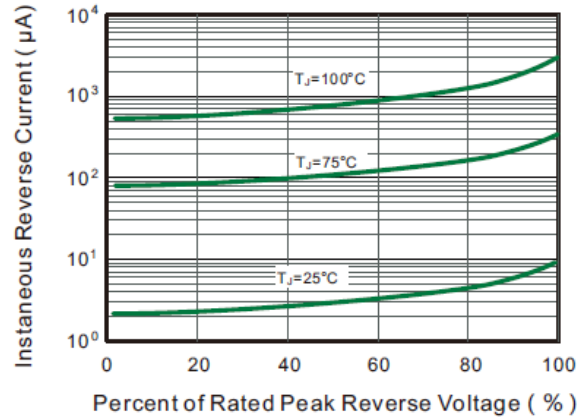

Figure 3. Typical Forward Characteristic

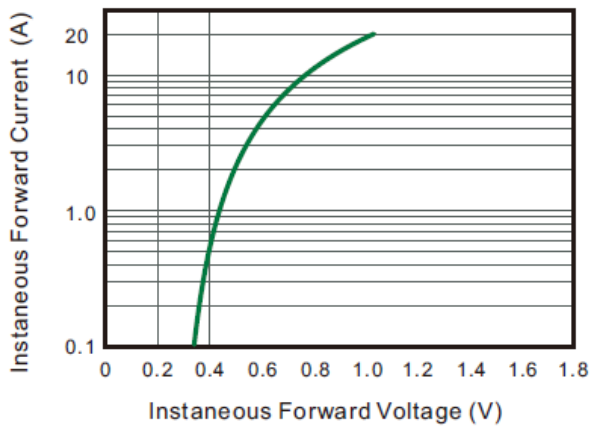

Figure 4. Typical Junction Capacitance

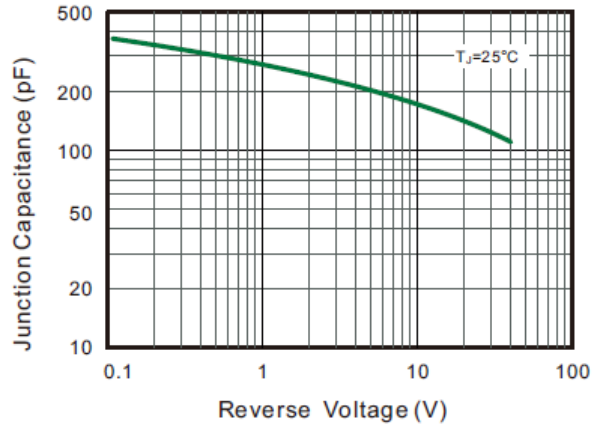

Figure 5. Maximum Non-Repetitive Peak Forward Surge Current

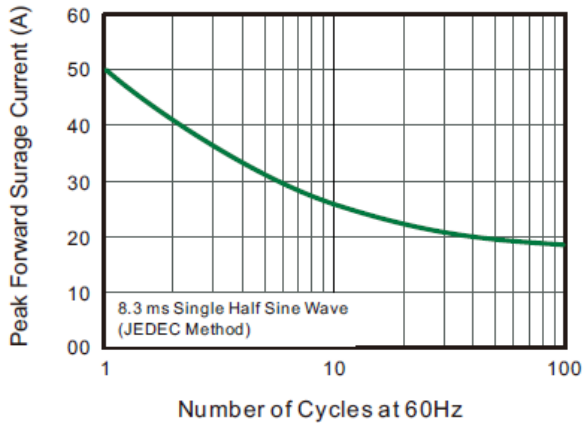
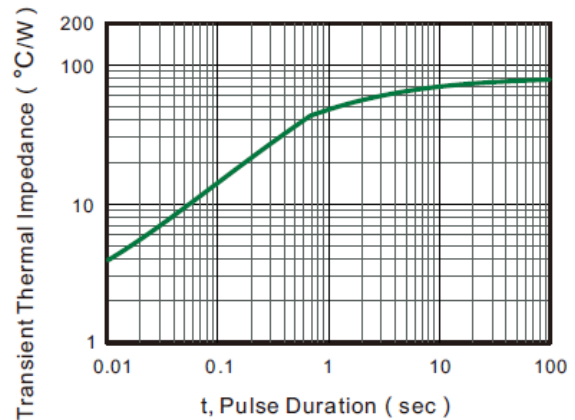

Figure 6. Typical Transient Thermal Impedance





PACKAGE INFORMATION

Dimension in SOD-123FL (Unit: mm)

Plastic surface mounted package; 2 leads

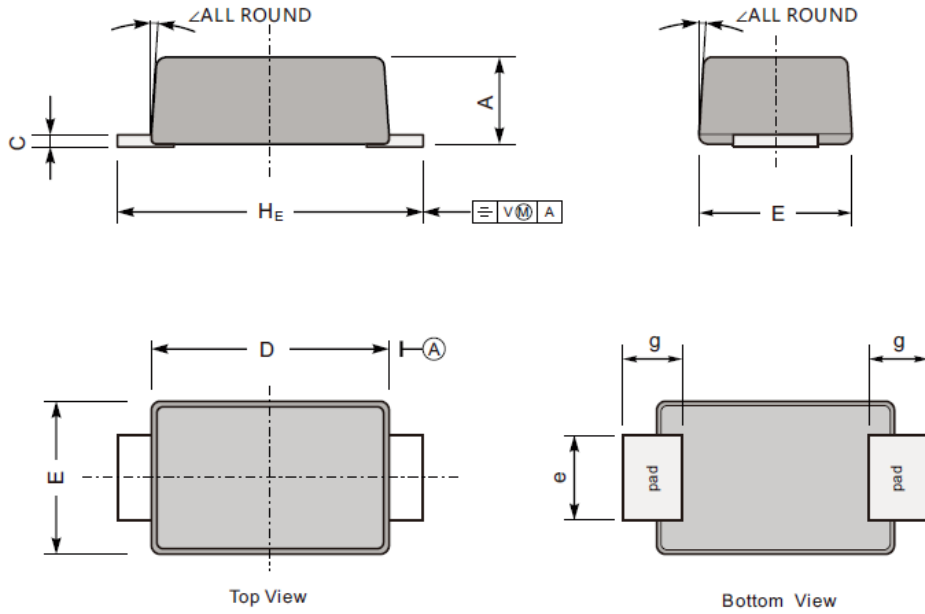

The recommended mounting pad size

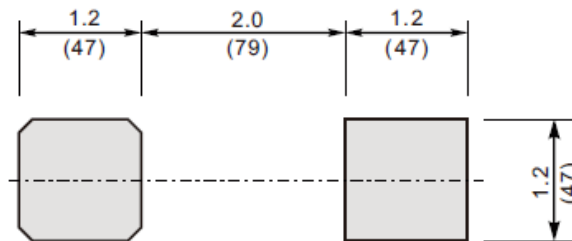

Unit: $\frac{\text{mm}}{\text{mil}}$

UNIT		A	C	D	E	e	g	H _E	\angle
mm	Max	1.1	0.20	2.9	1.9	1.1	0.9	3.8	7°
	min	0.9	0.12	2.6	1.7	0.8	0.7	3.5	
mil	max	43	7.9	114	75	43	35	150	
	min	35	4.7	102	67	31	28	138	



IMPORTANT NOTICE

AiT Components (AiT) reserves the right to make changes to any its product, specifications, to discontinue any integrated circuit product or service without notice, and advises its customers to obtain the latest version of relevant information to verify, before placing orders, that the information being relied on is current.

AiT Components' integrated circuit products are not designed, intended, authorized, or warranted to be suitable for use in life support applications, devices or systems or other critical applications. Use of AiT products in such applications is understood to be fully at the risk of the customer. As used herein may involve potential risks of death, personal injury, or servers property, or environmental damage. In order to minimize risks associated with the customer's applications, the customer should provide adequate design and operating safeguards.

AiT Components assumes to no liability to customer product design or application support. AiT warrants the performance of its products of the specifications applicable at the time of sale.