



## DESCRIPTION

The A4063 is a 2A Li-Ion battery switching charger intended for 5V adapters. Low power dissipation, an internal MOSFET and its compact package with minimum external components requirement makes the A4063 ideal for portable applications. The A4063 includes complete charge termination circuitry, automatic recharge and a  $\pm 1\%$  4.2V/4.35V float voltage.

External sense resistor and Reverse diode is not need. Build-in thermal feedback mechanism regulates the charge current to control the die temperature during high power operation or at elevated ambient temperature.

Battery charge current, charge timeout and end-of-charge indication parameters can program by external components. Additional features include shorted cell detection and overvoltage protection.

The A4063 is available in DFN10(3X3) package.

## ORDERING INFORMATION

Package Type	Part Number	
DFN10(3X3)	J10	A4063J10R-XXX
		A4063J10VR-XXX
Note	XXX: Output Voltage 420=4.2V; 435=4.35V V: Halogen free Package R: Tape & Reel SPQ: 3,000pcs/Reel	
AiT provides all RoHS products		

## FEATURES

- Very Low Power Dissipation
- 2A Maximum Charge Current
- Standalone Capability with no Requirement of External MOSFET, Sense Resistor or Blocking Diode
- Constant-Current/Constant-Voltage Operation with Thermal Regulation to Maximize Charge Rate Without Risk of Overheating
- Charges Single Cell Li-Ion Batteries Directly from USB Port
- Drainage Charge Current Thermal Regulation Status Outputs for LED or System Interface
- Preset 4.2V/4.35V float Voltage with  $\pm 1\%$  Accuracy
- Automatic Recharge
- Available in DFN10(3X3) package

## APPLICATION

- Cellular Telephones, PDA, MP3 Players
- Charging Docks and Cradles
- Handheld Battery-Powered Devices
- Handheld Computers

## TYPICAL APPLICATION

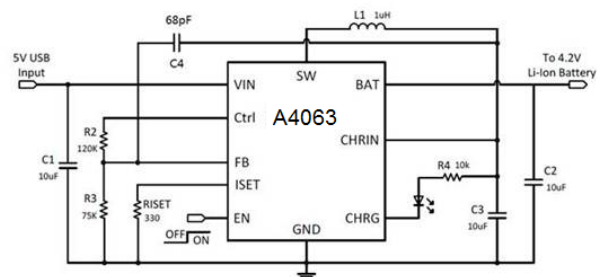



## PIN DESCRIPTION

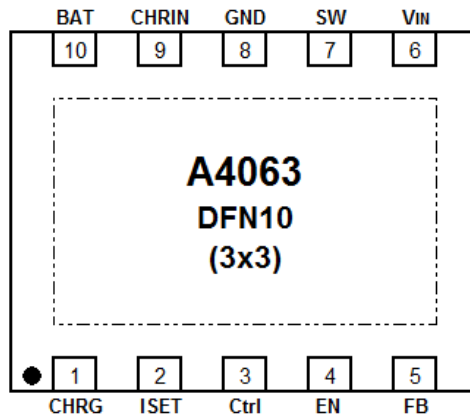

Top View

Pin #	Symbol	Function
1	CHRG	Open-Drain Charge Status Output. When the battery is charging, the CHRG pin is pulled low by an internal N-channel MOSFET. When the charge cycle is completed, When the A4063 detects an under voltage lockout condition, CHRG is forced high impedance.
2	ISET	Charge Current Program, Monitor the charge current and Shutdown. This pin set to 1V in constant-current mode. The charge current is programmed by connecting a 1% resistor, $R_{ISET}$ , to GND pin.
3	Ctrl	Sense Feedback Voltage Pin.
4	EN	Enable Input Pin. Pulling the EN pin low places the A4063 into a low power state where the BAT drain current drops to less than $3\mu A$ and the supply current is reduced to less than $50\mu A$ . For normal operation, pull the pin high.
5	FB	Battery Feedback Voltage.
6	$V_{IN}$	Positive Supply Voltage Input. This pin connects to the power devices inside the chip. $V_{IN}$ ranges from 4V to 5.5V for normal operation. Operation down to the under-voltage lockout threshold is allowed with current limited wall adapters. Decouple with a $10\mu F$ or larger surface mounted ceramic capacitor.
7	SW	Switch Node Connection. This pin connects to the drains of the internal main and synchronous power MOSFET switches. Connect to external inductor.
8	GND	Ground.
9	CHRIN	Power Path Output Voltage.
10	BAT	Battery Charger Output Terminal. Connect a $22\mu F$ ceramic chip capacitor between BAT and GND to keep the ripple voltage small.



## ABSOLUTE MAXIMUM RATINGS

Max Input Voltage	6.5V
T <sub>J</sub> , Max Operating Junction Temperature	125°C
T <sub>A</sub> , Ambient Temperature	-40°C~85°C
T <sub>S</sub> , Storage Temperature	-55°C~150°C
Lead Temperature & Time	260°C, 10s
ESD, HBM	>2000V

Stress beyond above listed "Absolute Maximum Ratings" may lead permanent damage to the device. These are stress ratings only and operations of the device at these or any other conditions beyond those indicated in the operational sections of the specifications are not implied. Exposure to absolute maximum rating conditions for extended periods may affect device reliability.

## RECOMMENDED OPERATING CONDITION

Parameter	Symbol	Min	Max	Unit
Input Voltage Range			6	V
Operating Junction Temperature	T <sub>J</sub>	-40	85	°C



## ELECTRICAL CHARACTERISTICS

$V_{DD}=5V$ ,  $T_A=25^{\circ}C$

Parameter	Symbol	Conditions	Min	Typ	Max	Unit
Adapter/USB Voltage Range	$V_{IN}$		2.6		6	V
Input Supply Current	$I_{CC}$	Charge Mode, $R_{ISET}=10k$ , Standby Mode (Charge Terminated) <sup>NOTE1</sup>		300	2000	uA
		Shutdown Mode ( $R_{ISET}$ Not Connected)		200	500	
		$V_{CC} < V_{BAT}$ , or $V_{CC} < V_{UV}$		30	50	
Regulated Output (Float) Voltage	$V_{FLOAT}$	$0^{\circ}C \leq T_A \leq 85^{\circ}C$ , $I_{BAT} = 40mA$	4.158	4.2	4.242	V
			4.3065	4.35	4.3935	
BAT Pin Current	$I_{BAT}$	$R_{ISET} = 1.8k$ , $R_2=100k$ , $R_3=75k$ , Current Mode	450	500	550	mA
		$R_{ISET} = 0.41k$ , $R_2=110k$ , $R_3=75k$ , Current Mode	1.44	1.6	1.76	A
		$R_{ISET} = 0.33k$ , $R_2=120k$ , $R_3=75k$ , Current Mode	1.8	2	2.2	A
		Standby Mode, $V_{BAT} = 4.2V$ Shutdown Mode ( $R_{ISET}$ Not Connected) Sleep Mode, $V_{CC} = 0V$	0	-2.5 1 1	-6 5 5	uA
Trickle Charge Current	$I_{TRIKL}$	$V_{BAT} < V_{TRIKL}$ , $R_{ISET}=2k$	20	45	70	mA
Trickle Charge Threshold Voltage	$V_{TRIKL}$	$R_{ISET}=10k$ , $V_{BAT}$ Rising	2.8	2.9	3.0	V
Trickle Charge Hysteresis Voltage	$V_{TRHYS}$	$R_{ISET}=10k$	60	85	110	mV
ISET Pin Voltage	$V_{ISET}$	$R_{ISET}=10k$ , Current Mode	0.93	1	1.07	V
CHRG Pin Output Low Voltage	$V_{CHRG}$	$I_{CHRG}=5mA$		0.315	0.6	V
Recharge Battery Threshold Voltage	$\Delta V_{RECHRG}$	$V_{FLOAT} - V_{RECHRG}$	100	160	200	mV

NOTE1: Supply current includes ISET pin current (approximately 100uA) but does not include any current delivered to the battery through the BAT pin (approximately 100mA).



## TYPICAL PERFORMANCE CHARACTERISTIC

Tested under  $T_A=25^\circ\text{C}$ , unless otherwise specified

### 1. $I_{BAT}$ vs. $V_{BAT}$

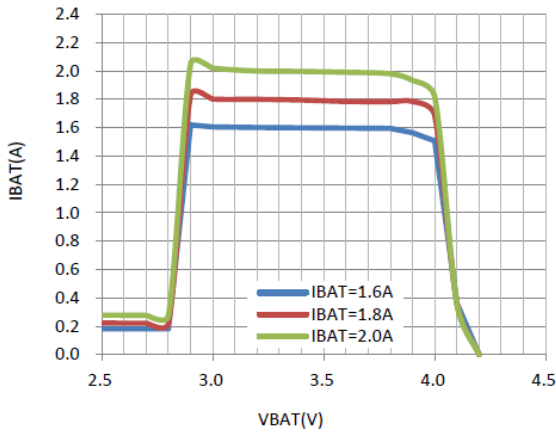

### 2. Efficiency vs. $V_{BAT}$

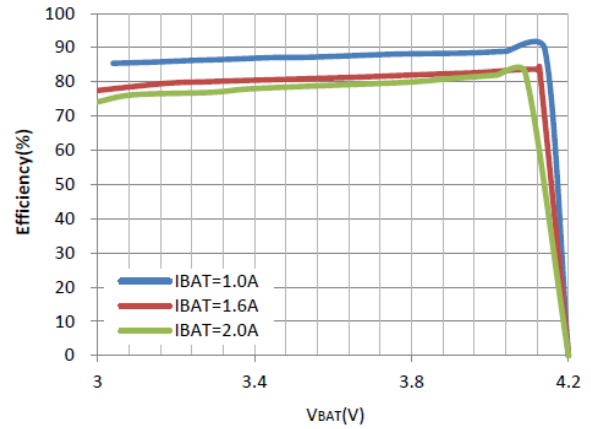

### 3. $I_{BAT}$ vs. $R_{ISET}$

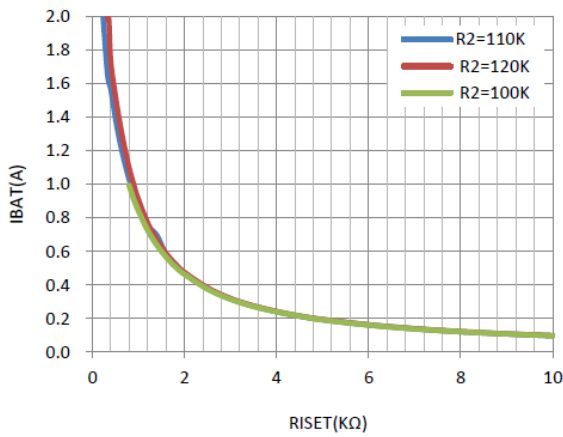

### 4. $I_{SET}$ Pin Pull-up Current vs. Temperature and $V_{IN}$

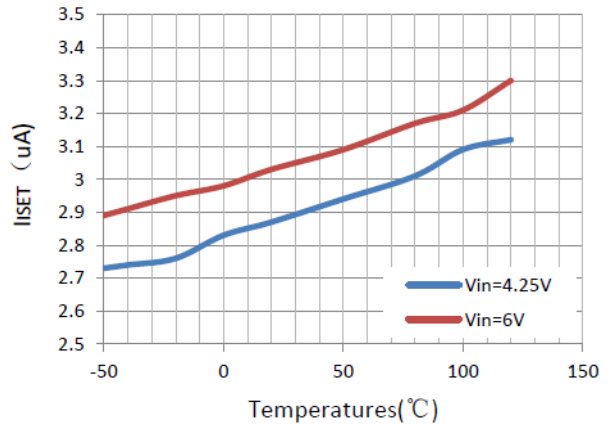

### 5. Regulated Output (Float) Voltage vs. Temperature

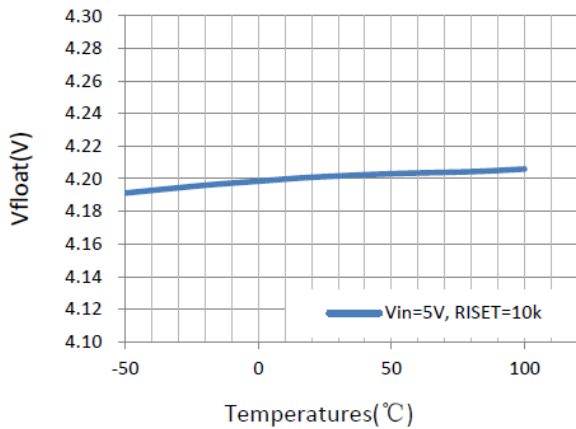

### 6. CHRG pin Current vs. Temperature (strong Pull-down State)

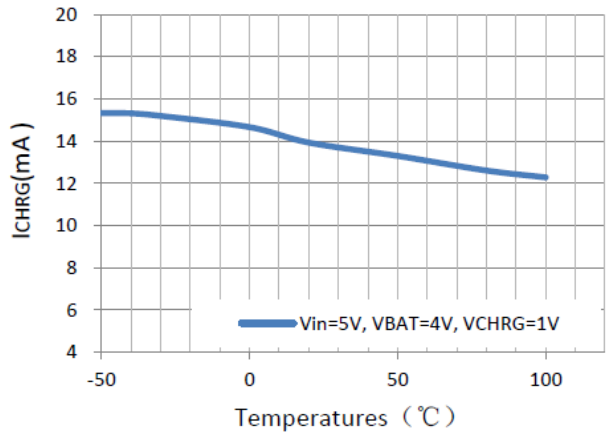



7. CHRG Current vs. Temperature

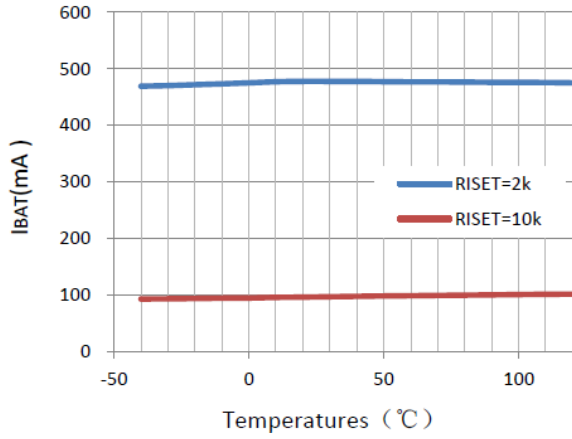

8. V<sub>SET</sub> vs. Temperature

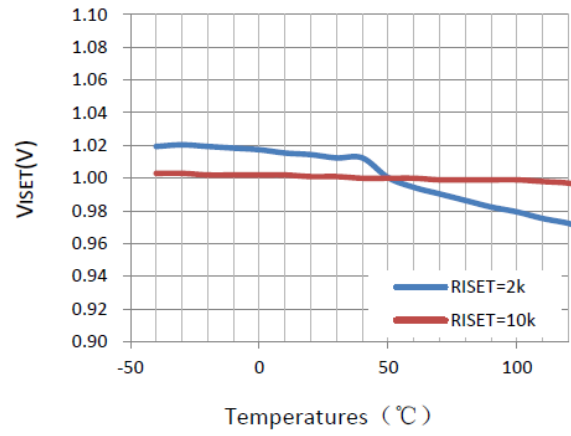



**BLOCK DIAGRAM**

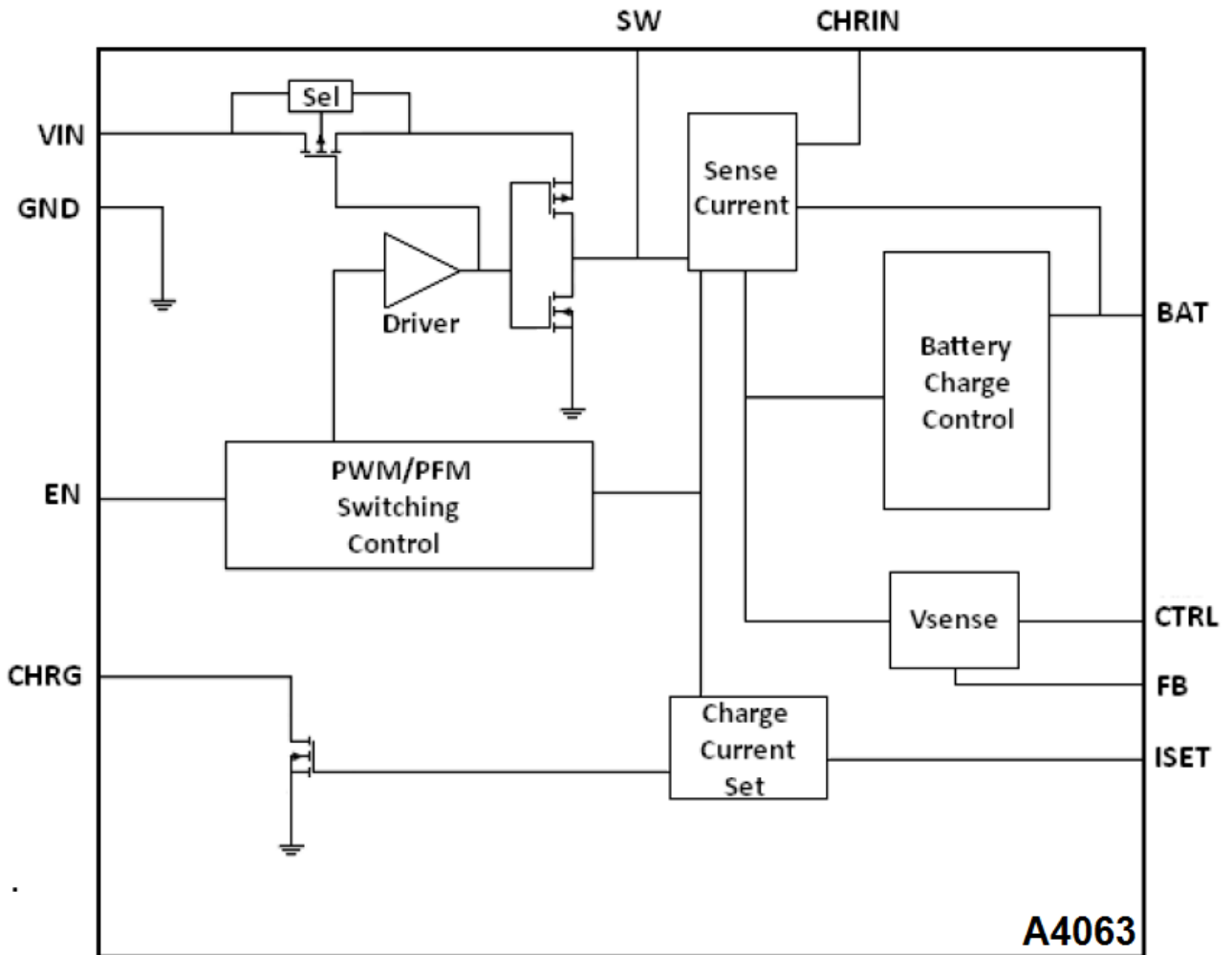



## DETAILED INFORMATION

### General description

The A4063 is a constant current, constant voltage Li-Ion battery switching charger controller. The charge current is set by an external sense resistor ( $R_{ISET}$ ) across the ISET and GND pins. The final battery float voltage is internally set to 4.2V/4.35V per cell. For batteries like lithium-ion that require accurate final float voltage, the internal reference, voltage amplifier and the resistor divider provide regulation with  $\pm 1\%$  accuracy.

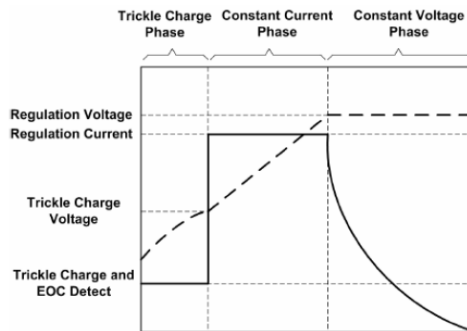

A charge cycle begins when the voltage at the  $V_{CC}$  pin rises above the UVLO level and is 250mV or more greater than the battery voltage. At the beginning of the charge cycle, if the battery voltage is less than the trickle charge threshold, 2.9V for the 4.2 version, the charger goes into trickle charge mode. The trickle charge current is internally set to 10% of the full-scale current. The charge current is programmable by setting the value of a precision resistor connected from the ISET pin to ground. The charge current is 1000 times of the current out of the ISET pin. The program resistor and the charge current are calculated using the following equations:

$$R_{ISET} \approx \frac{1000V}{I_{BAT}}$$

The charge current out of the BAT pin can be determined at any time by monitoring the ISET pin voltage using the following equation:

$$I_{BAT} \approx \frac{V_{ISET}}{R_{ISET}} \times 1000$$

When the battery voltage approaches the programmed float voltage, the charge current will start to decrease. It terminates the charge cycle when the charge current falls to 10% of the full-scale value after the final float voltage is reached. When the ISET pin voltage falls below 100mV for longer than  $t_{TERM}$  (typically 1ms), charging is terminated. The charge current is latched off and the LC6000 enters standby mode, where the input supply current drops to 200 $\mu$ A.





(Note: C/10 termination is disabled in trickle charging and thermal limiting modes).

### Manual Shutdown

Floating the ISET pin by removing the resistor from ISET pin to ground can put the device in shutdown mode. The battery drain current is thus reduced to less than 5 $\mu$ A and the supply current to less than 50 $\mu$ A. Reconnecting the resistor back will restart a new charge cycle.

Once manually shutdown, the CHRГ pin is in a weak pull-down state if V<sub>IN</sub> is above UVLO voltage. The CHRГ pin is in a high impedance state if the A4063 is in under voltage lockout mode.

### Automatic Recharge

After the termination of the charge cycle, the A4063 constantly monitors the BAT pin voltage and starts a new charge cycle when the battery voltage falls below 4.05V, keeping the battery at fully charged condition. CHRГ output enters a strong pull-down state during recharge cycles.

### Inductor Selection

The peak-to-peak ripple is limited to 30% of the maximum output current. This places the peak current far enough from the minimum over current trip level to ensure reliable operation while providing enough current ripples for the current mode converter to operate stably. In this case, for 1.6A maximum output current, the maximum inductor ripple current is 667mA. The inductor size is estimated as following equation:

$$I_{IDEAL} = \frac{V_{IN(MAX)} - V_{BAT} \times D_{MIN}}{I_{RIPPLE} \times F_{OSC}}$$

### Layout Considerations

C<sub>IN</sub> must be close to Pins V<sub>IN</sub> and GND, the loop area formed by C<sub>IN</sub> and GND must be minimized. Place C<sub>CHRIN</sub> as close to Pins CHRIN and GND. The PCB copper area associated with SW pin must be minimized to avoid the potential noise problem. FB Resistors and the traces connecting to the FB pin must not adjacent to the SW net on the PCB layout to avoid the noise problem. ISET resistor must be as far away with the SW net as possible. The thermal pad under the IC must be tied to the ground area on the top layer, and use via to connect this ground area to any internal ground planes.



## PACKAGE INFORMATION

Dimension in DFN10(3x3) (Unit: mm)

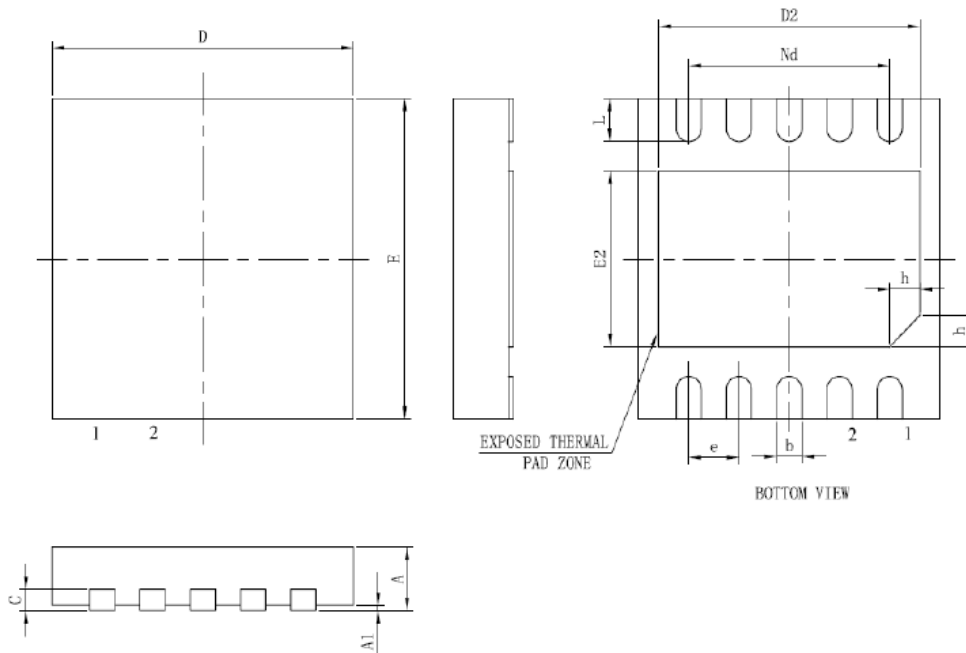

Symbol	Min	Max
A	0.70	0.80
A1	-	0.05
b	0.18	0.30
c	0.18	0.25
D	2.90	3.10
D2	2.40	2.60
e	0.50 BSC	
Nd	2.00 BSC	
E	2.90	3.10
E2	1.45	1.65
L	0.30	0.50
h	0.20	0.30

## IMPORTANT NOTICE



AiT Semiconductor Inc. (AiT) reserves the right to make changes to any its product, specifications, to discontinue any integrated circuit product or service without notice, and advises its customers to obtain the latest version of relevant information to verify, before placing orders, that the information being relied on is current.

AiT Semiconductor Inc.'s integrated circuit products are not designed, intended, authorized, or warranted to be suitable for use in life support applications, devices or systems or other critical applications. Use of AiT products in such applications is understood to be fully at the risk of the customer. As used herein may involve potential risks of death, personal injury, or severe property, or environmental damage. In order to minimize risks associated with the customer's applications, the customer should provide adequate design and operating safeguards.

AiT Semiconductor Inc. assumes to no liability to customer product design or application support. AiT warrants the performance of its products of the specifications applicable at the time of sale.