



## DESCRIPTION

The A4773 is a load switch which provides full protection to systems and loads which may encounter large current conditions. A4773 offers a 95mΩ current-limited switch which can operate over an input voltage range of 2.5 ~ 5.5V. The current limit can be externally programmed by a precision resistor, ranges from 75mA ~ 1.7A.

Switch control is by a logic input (EN) capable of interfacing directly with low voltage control signals. Current is prevented from flowing when the switch is off and the output voltage is higher than the input voltage. A4773 also features thermal shutdown protection which shuts off the switch to prevent damage to the part when a continuous over-current condition causes excessive heating. When the switch current reaches the current limit, the parts operate in a constant-current mode to prohibit excessive currents from causing damage. The A4773 will not turn off after a current limit fault, but will rather remain in the constant current mode indefinitely. The nFAULT output asserts low during over-current and reverse-voltage conditions.

The A4773 is available in DFN6(2x2) Package.

## ORDER INFORMATION

Package Type	Part Number	
DFN6	J6	A4773J6R
		A4773J6VR
Note	R: Tape & Reel V: Halogen free Package	
AiT provides all RoHS products Suffix " V " means Halogen free Package		

## FEATURES

- Up to 1.5A Max Load current
- Accurate Current-limit threshold: +/-5%
- Programmable Current-limit : 75mA ~ 1.7A
- Fast Over-Current Response
- Fault Flag Output: nFAULT Pin
- Reversed Current blocking
- Thermal Shutdown, UVLO protection
- Available in DFN6(2x2) Package

## APPLICATION

- USB ports/Hubs
- Hot Swaps
- Cell phones
- Tablet PC
- Set Top Box
- PC motherboard
- Handheld Devices

## TYPICAL APPLICATION

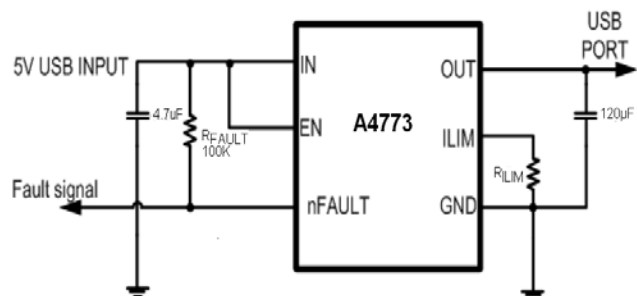



## PIN DESCRIPTION

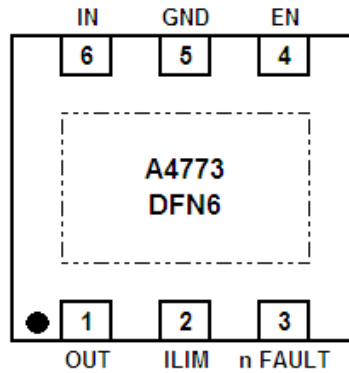

Top View

Pin #	Symbol	Function
1	OUT	Current limit Output. Bypass with a capacitor that is greater than 120 $\mu$ F if used for USB
2	ILIM	Current limit threshold setting pin. Connect a resistor from this pin to GND to set different current limit values
3	nFAULT	Fault flagging pin. Connect a pull up resistor to IN, when in fault conditions, this pin is asserted low
4	EN	Enable pin
5	GND	Ground
6	IN	Power input. Bypass with a 4.7 $\mu$ F capacitor to GND



## ABSOLUTE MAXIMUM RATINGS

IN to GND	-0.3V ~ 6V
OUT, ILIM, nFAULT, EN to GND	-0.3V ~ VIN+0.3V
OUT to GND Current	Internally limited
Maximum Power Dissipation	1.0W
Operating Temperature Range	-40°C ~ 85°C
Storage Temperature Range	-55°C ~ 150°C

Stress beyond above listed "Absolute Maximum Ratings" may lead permanent damage to the device. These are stress ratings only and operations of the device at these or any other conditions beyond those indicated in the operational sections of the specifications are not implied. Exposure to absolute maximum rating conditions for extended periods may affect device reliability.



## ELECTRICAL CHARACTERISTICS

$V_{IN} = 5V$ , unless otherwise specified. Typical values are at  $T_A = 25^\circ C$

Parameter	Conditions	MIN	TYP.	MAX	Unit
Input Voltage Range		2.5	-	5.5	V
Input UVLO	Rising, Hysteresis=25mV	-	2.35	-	V
Input Supply Current	$R_{ILIM}=20K$	-	120	-	$\mu A$
Input Shutdown Current		-	0.5	1.5	$\square \mu A$
Power Switch On Resistance	$I_{SW} = 500mA$	-	95	-	m $\Omega$
	$I_{SW} = 500mA$ , $-40^\circ C \leq T_J \leq 120^\circ C$	-	-	145	
Current limit Threshold	$R_{ILIM}=15K$	-	1.705	-	A
	$R_{ILIM}=20K$	-	1.295	-	
	$R_{ILIM}=49.9K$	-	0.520	-	
Response time to Short-circuit		-	1	-	$\mu S$
Reverse-voltage Threshold	$V_{OUT}-V_{IN}$	-	150	-	mV
Reverse Leakage Current	$V_{OUT}=5.5V, V_{IN}=0V$ , $V_{EN}=High$	-	0.5	2	$\mu A$
EN Input Logic High threshold	$V_{nFAULT}=5.5V$	-	-	1	V
EN Input Logic Low threshold		0.66	-	-	V
nFAULT Output Low Voltage	$I_{nFAULT} = 1mA$	-	70	170	mV
nFAULT Output Leakage		-	-	1	$\mu A$
nFAULT Deglitch Time	De-assertion due to Over-current	-	9	-	mS
	De-assertion due to Reverse-Voltage	-	4.5	-	
Thermal Shutdown		-	160	-	$^\circ C$
Thermal Shutdown In Current Limit		-	135	-	$^\circ C$
Thermal Shutdown Hysteresis		-	15	-	$^\circ C$



**TYPICAL PERFORMANCE CHARACTERISTICS**

1. Turn on Delay and Rise time  
 $V_{IN}=5V$ ,  $R_{LIM}=20K$ ,  $R_{OUT}=5\Omega$   
CH1: Output Voltage; CH2: Enabled pin Voltage; CH4: Input Current

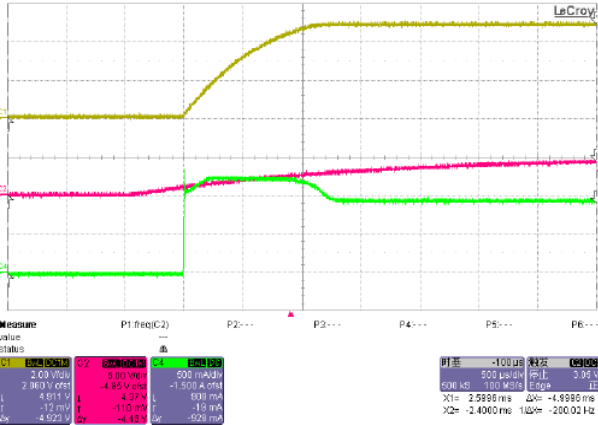

2. Turn off Delay and Fall Time  
 $V_{IN}=5V$ ,  $R_{LIM}=20K$ ,  $R_{OUT}=5\Omega$   
CH1: Output Voltage; CH2: Enabled pin Voltage; CH4: Input Current

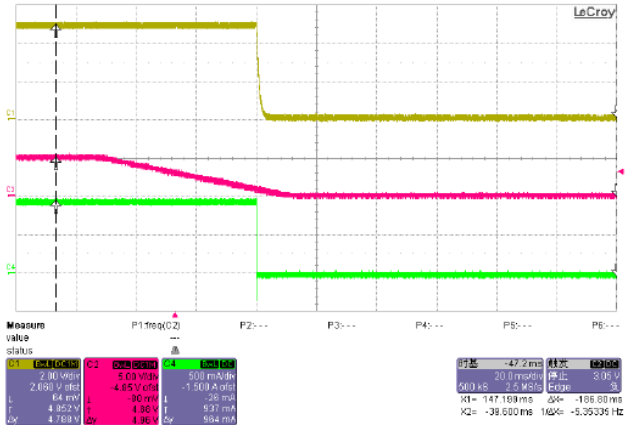

3. Device Enabled into short-Circuit  
 $V_{IN}=5V$ ,  $R_{LIM}=20K$ ,  $R_{OUT}=0\Omega$   
CH2: Enabled pin Voltage; CH4: Input Current

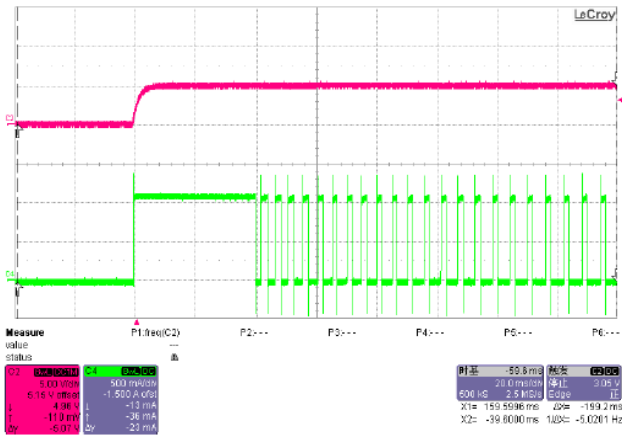



5. Full Load to Short-Circuit  
 $V_{IN}=5V$ ,  $R_{LIM}=20K$   
 CH1: Output Voltage; CH2: nFAULT pin Voltage;  
 CH4: Input Current

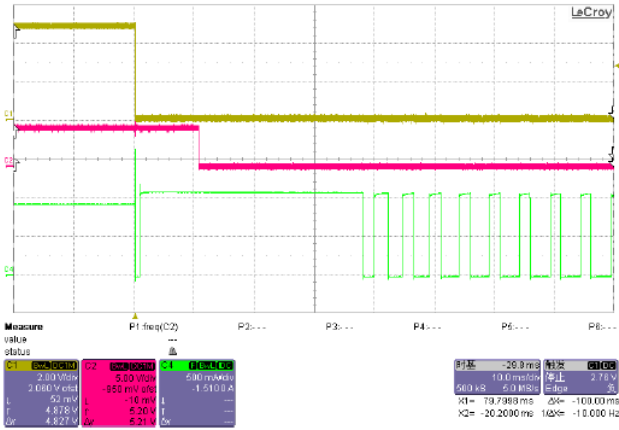

6. Short-Circuit to Full load  
 $V_{IN}=5V$ ,  $R_{LIM}=20K$   
 CH1: Output Voltage; CH2: nFault pin Voltage;  
 CH4: Input Current

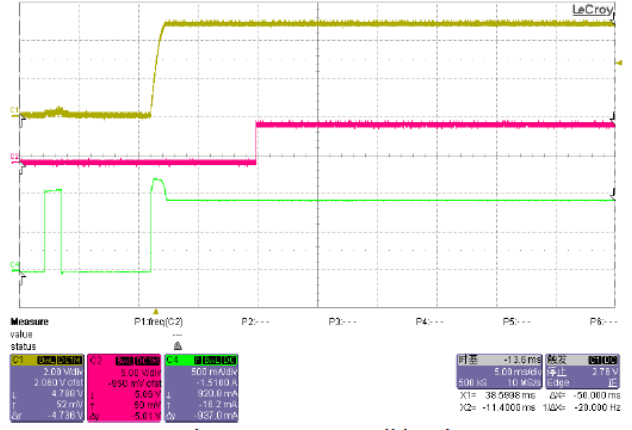

7. No-load to Short-Circuit  
 $V_{IN}=5V$ ,  $R_{LIM}=20K$   
 CH1: Output Voltage; CH2: nFAULT pin Voltage;  
 CH4: Input Current

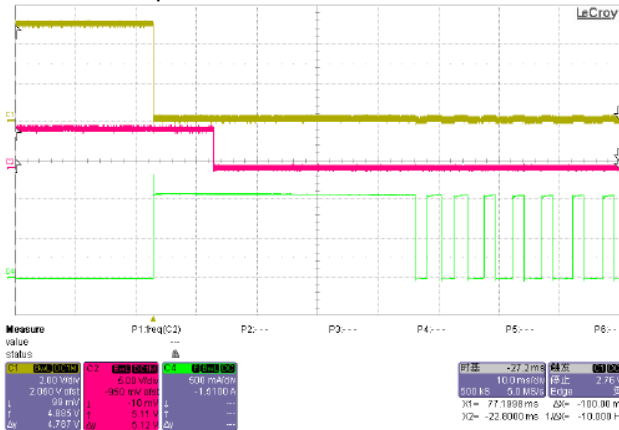

8. Short-Circuit to No-load  
 $V_{IN}=5V$ ,  $R_{LIM}=20K$   
 CH1: Output Voltage; CH2: nFAULT pin Voltage;  
 CH4: Input Current

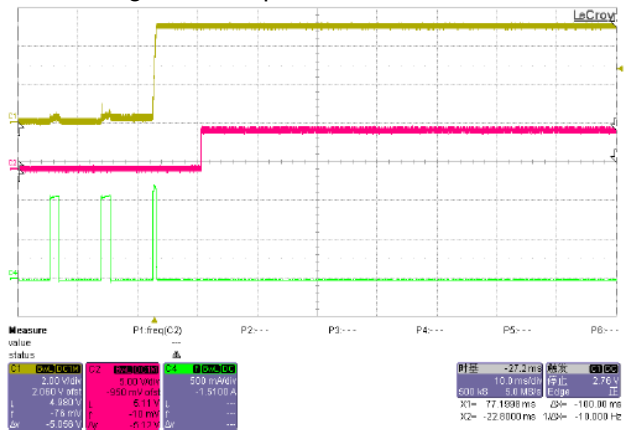



9. No-load to 1Ω-load  
 $V_{IN}=5V, R_{ILIM}=20K$   
 CH1: Output Voltage; CH2: nFAULT pin Voltage  
 CH4: Input Current

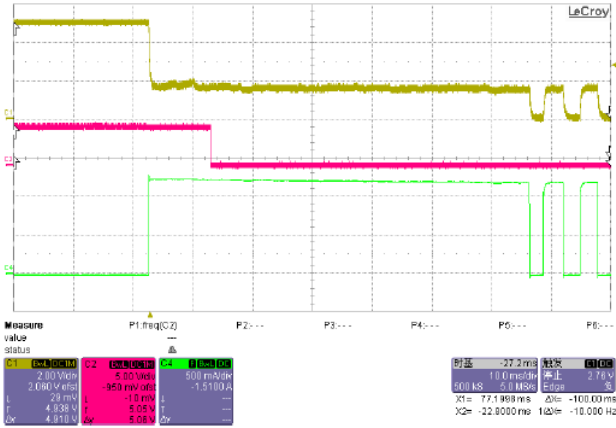

10. 1Ω-load to No-load  
 $V_{IN}=5V, R_{ILIM}=20K$   
 CH1: Output Voltage; CH2: nFAULT pin Voltage  
 CH4: Input Current

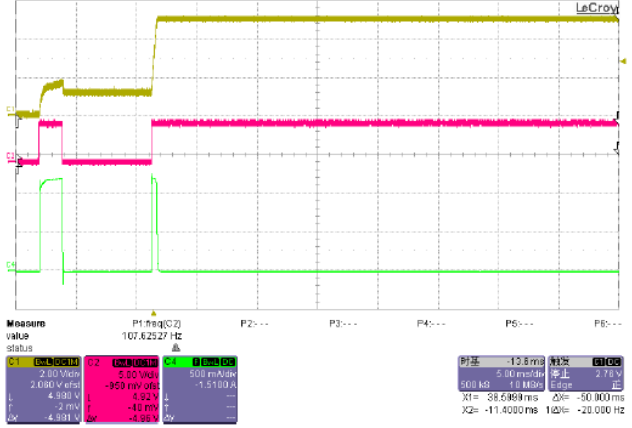

11. Input Voltage from 5V into 0V  
 $V_{OUT}=5V, R_{ILIM}=20K, R_{OUT}=10Ω$   
 CH1: Output Voltage; CH2: nFAULT pin Voltage  
 CH3: Input Voltage; CH4: Input Current

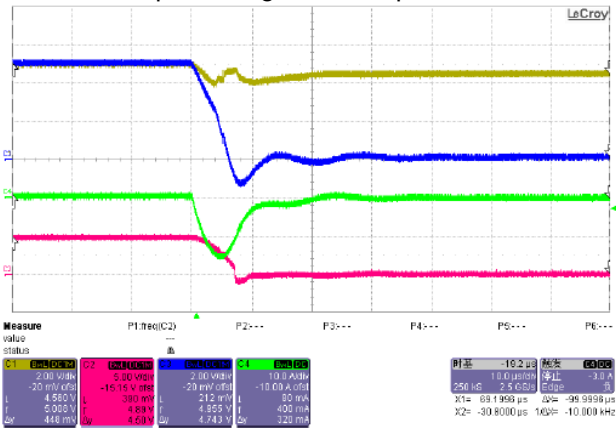

12. Input Voltage from 0V into 5V  
 $V_{OUT}=5V, R_{ILIM}=20K, R_{OUT}=10Ω$   
 CH1: Output Voltage; CH2: nFAULT pin Voltage  
 CH3: Input Voltage; CH4: Input Current

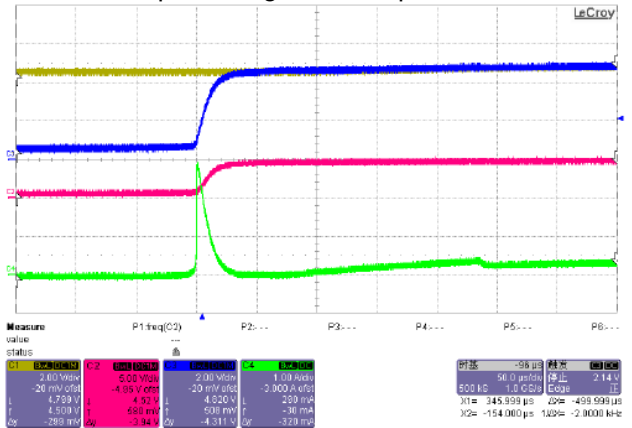



13. Switch current VS Drain-Source Voltage

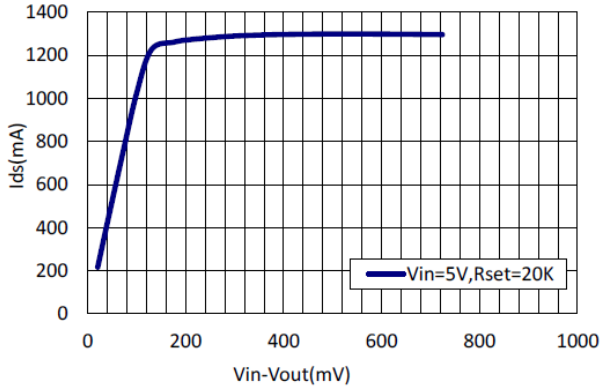

14. Switch current VS Drain-Source Voltage

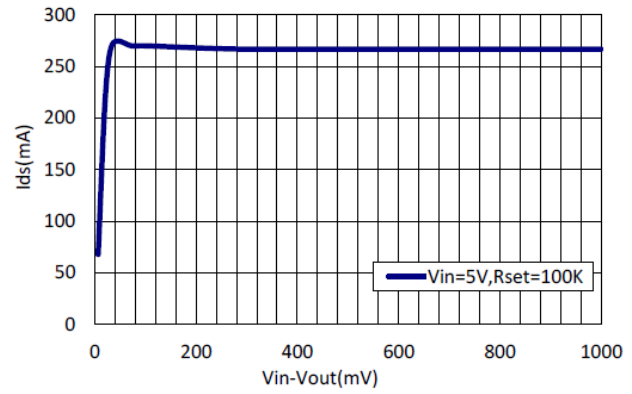

15. Switch current VS Drain-Source Voltage

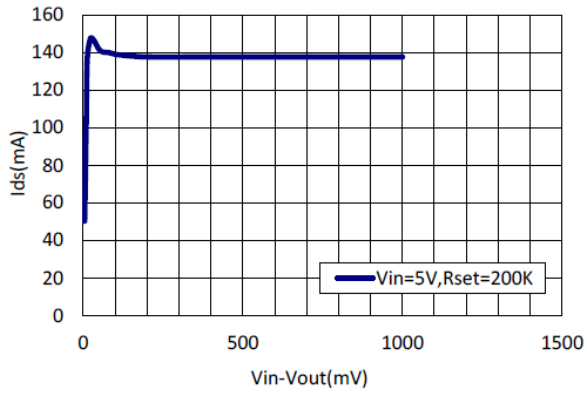





**BLOCK DIAGRAM**

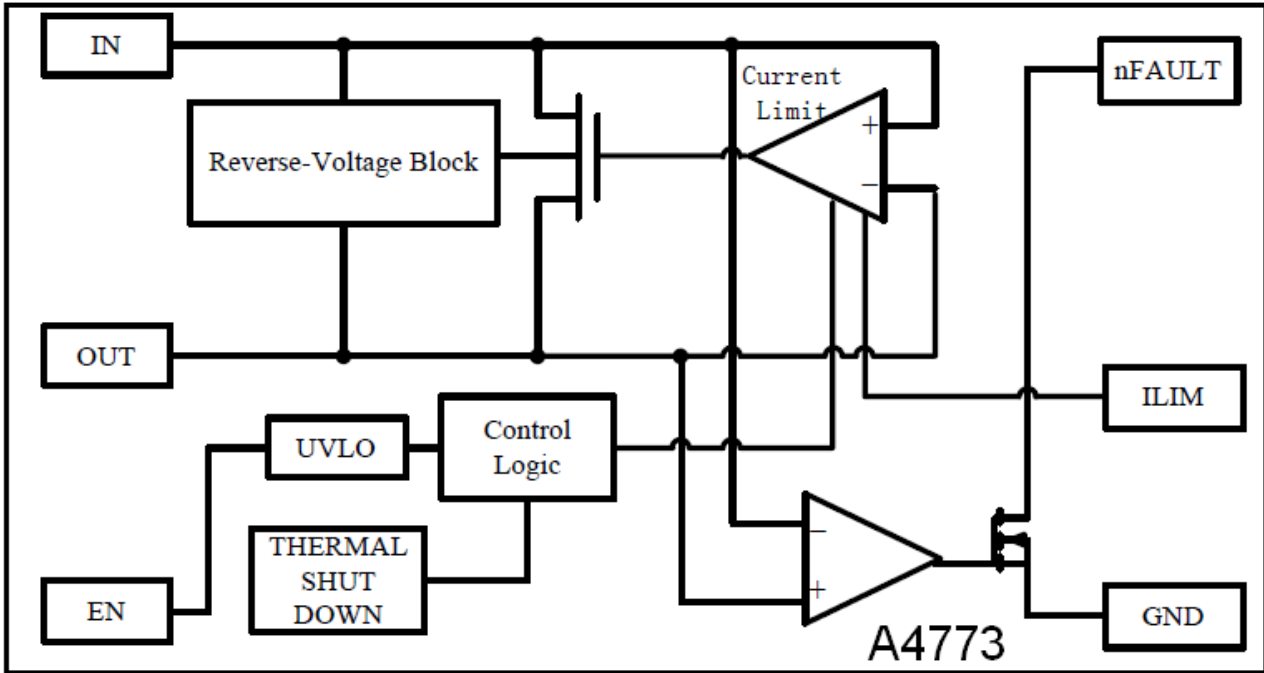



## DETAILED INFORMATION

### Input output Capacitance

Input and output capacitance improves the performance of the device; the actual capacitance should be optimized for the particular application. For all applications, a 4.7µF or greater ceramic bypass capacitor between IN and GND is recommended as close to the device as possible for local noise de-coupling. This precaution reduces ringing on the input due to power-supply transients. Additional input capacitance may be needed on the input to reduce voltage overshoot from exceeding the absolute maximum voltage of the device during heavy transient conditions. This is especially important during bench testing when long, inductive cables are used to connect the evaluation board to the bench power-supply. Placing a high-value electrolytic capacitor on the output pin is recommended when large transient currents are expected on the output.

### Setting the Current Limit Threshold

R <sub>LIM</sub> (KΩ)	Typical Current Limit (mA)
200	138
180	152
151	179
100	266
82	324
68	389
51	520
43	612
30	873
20	1295
15.1	1705

$$R_{lim}(K) = 1.3A \times 20K / I_{target}$$

### Power Dissipation

During normal operation as a switch, the power dissipated in the part will depend upon the level at which the current limit is set. The maximum allowed setting for the current limit is 1A and this will result in a power dissipation of,

$$P = (I_{LIM})^2 \times R_{DS} = (1)^2 \times 0.10 = 100mW$$

If the part goes into current limit the maximum power dissipation will occur when the output is shorted to ground. This is more power than the package can dissipate, but the thermal shutdown of the part will activate to protect the part from damage due to excessive heating. A short on the output will cause the part to operate in a constant current state dissipating a worst case power of,

$$P(\max) = V_{IN}(\max) \times I_{LIM}(\max) = 5.5 \times 1 = 5W$$

This large amount of power will activate the thermal shutdown and the part will cycle in and out of thermal shutdown so long as the ON pin is active and the short is present.

Current Limit Threshold VS R<sub>LIM</sub>

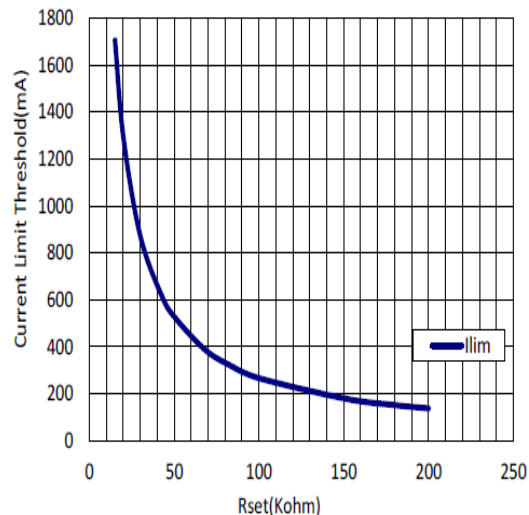



## Function Description

The A4773 is a load switch which provides full protection to systems and loads which may encounter large current conditions. A4773 offers a 95mΩ current-limited switch which can operate over an input voltage range of 2.5 ~ 5.5V. The current limit can be externally programmed by a precision resistor, ranges from 75mA ~ 1.7A. A4773 also features reverse voltage blocking, UVLO, and thermal shutdown to protect IC from overheating. An nFAULT flag output provides a pull-down signal to indicate fault conditions.

### Current Limiting

The current limit ensures that the current through the switch doesn't exceed a maximum value while not limiting at less than a minimum value. The current at which the parts will limit is adjustable through the selection of an external resistor connected to ILIM. Information for selecting the resistor is found in the Application Info section. A4773 thermal cycles if an overload condition is present long enough to activate thermal limiting in any of the above cases. The device turns off when the junction temperature exceeds 135°C (typ) while in current limit. The device remains off until the junction temperature cools 10°C (typ) and then restarts

### Reverse-Voltage Blocking

The reverse-voltage protection feature turns off the Power MOSFET whenever the output voltage exceeds the input voltage by 150mV (typ) for 4-ms (typ). This prevents damage to devices on the input side of the A4773 by preventing significant current from sinking into the input capacitance. The A4773 allow the power MOSFET to turn on once the output voltage goes below the input voltage for the same 4-ms deglitch time. The reverse-voltage condition also asserts the nFAULT output (active-low) after 4-ms. During "OFF" condition, the reverse-voltage blocking function is still in effect, preventing any current floating from OUT to IN even when the device is not in use.

### nFAULT FLAG

The FAULT open-drain output is asserted (active low) during an overcurrent, over temperature or reverse-voltage condition. The A4773 asserts the FAULT signal until the fault condition is removed and the device resumes normal operation. The nFAULT signal is de-asserted once device power is cycled or the enable is toggled and the device resumes normal operation. The A4773 and A4773is designed to eliminate false nFAULT reporting by using an internal delay "deglitch" circuit for overcurrent (9-ms typ) and reverse-voltage (4.5-ms typ) conditions without the need for external circuitry. This ensures that nFAULT is not accidentally asserted due to normal operation such as starting into a heavy capacitive load. The deglitching circuitry delays entering and leaving fault conditions. Over temperature conditions are not deglitched and assert the nFAULT signal immediately.



## PACKAGE INFORMATION

Dimension in DFN6 (Unit: mm)

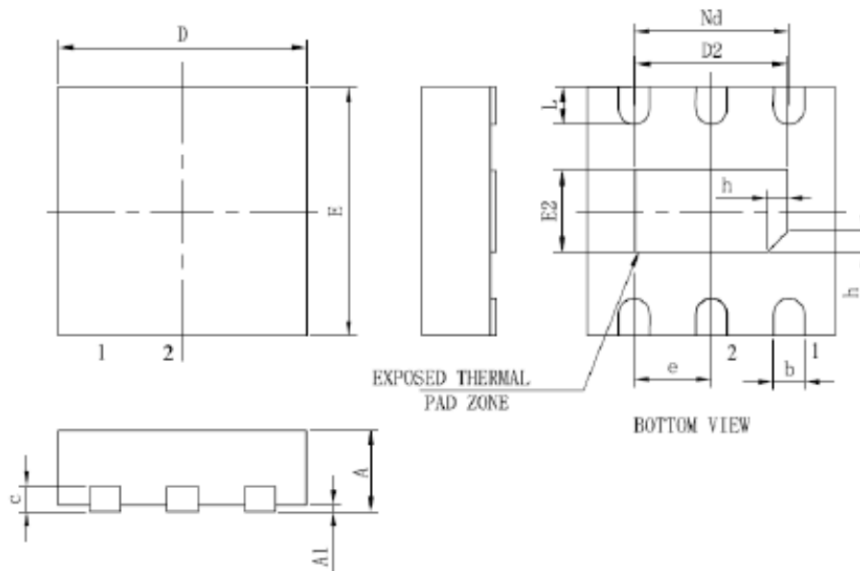

Symbol	Min	Max
A	0.700	0.800
A1	0.000	0.050
b	0.250	0.350
c	0.180	0.250
D	1.950	2.050
D2	1.000	1.450
e	0.65BSC	
Nd	1.30BSC	
E	1.950	2.050
E2	0.500	0.850
L	0.250	0.400
h	0.100	0.200



## IMPORTANT NOTICE

AiT Semiconductor Inc. (AiT) reserves the right to make changes to any its product, specifications, to discontinue any integrated circuit product or service without notice, and advises its customers to obtain the latest version of relevant information to verify, before placing orders, that the information being relied on is current.

AiT Semiconductor Inc.'s integrated circuit products are not designed, intended, authorized, or warranted to be suitable for use in life support applications, devices or systems or other critical applications. Use of AiT products in such applications is understood to be fully at the risk of the customer. As used herein may involve potential risks of death, personal injury, or server property, or environmental damage. In order to minimize risks associated with the customer's applications, the customer should provide adequate design and operating safeguards.

AiT Semiconductor Inc. assumes to no liability to customer product design or application support. AiT warrants the performance of its products of the specifications applicable at the time of sale.