



DESCRIPTION

The AM3424 is available in SOT-26 Package

ORDERING INFORMATION

Package Type	Part Number	
SOT-26	E6	AM3424E6R
		AM3424E6VR
Note	V: Halogen free Package R: Tape & Reel	
AiT provides all RoHS products Suffix " V " means Halogen free Package		

FEATURES

- 30V/7.4A,
 $R_{DS(ON)} = 17m\Omega(\text{max.}) @ V_{GS} = 10V$
 $R_{DS(ON)} = 21.5m\Omega(\text{max.}) @ V_{GS} = 4.5V$
- Reliable and Rugged
- Available in SOT-26 Package

APPLICATION

- Power Management in Notebook Computer, Portable Equipment and Battery Powered Systems.
- Load Switch

PIN DESCRIPTION

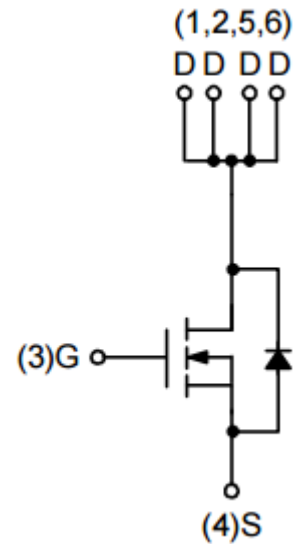

N-Channel MOSFET



PIN DESCRIPTION

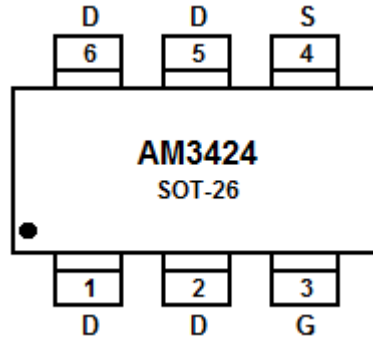

Top View

Pin #	Symbol	Function
1,2,5,6	D	Drain
3	G	Gate
4	S	Source



ABSOLUTE MAXIMUM RATINGS

T_A = 25°C, unless otherwise noted

V _{DSS} , Drain-Source Voltage		30V
V _{GSS} , Gate-Source Voltage		±20V
I _D ^{NOTE1} , Continuous Drain Current (V _{GS} =10V)	T _A =25°C	7.4A
	T _A =70°C	5.8A
I _{DM} ^{NOTE1} , 300µs Pulsed Drain Current (V _{GS} =10V)		21A
I _S ^{NOTE1} , Diode Continuous Forward Current		1A
T _J , Maximum Junction Temperature		150°C
T _{STG} , Storage Temperature Range		-55°C~150°C
P _D ^{NOTE1} , Maximum Power Dissipation	T _A =25°C	1.4W
	T _A =70°C	0.88W
R _{θJA} ^{NOTE1} , Thermal Resistance-Junction to Ambient	t ≤10s	60°C/W
	Steady State	90°C/W

Stress beyond above listed "Absolute Maximum Ratings" may lead permanent damage to the device. These are stress ratings only and operations of the device at these or any other conditions beyond those indicated in the operational sections of the specifications are not implied. Exposure to absolute maximum rating conditions for extended periods may affect device reliability.

NOTE1: Surface Mounted on 1in² pad area, t ≤10sec.



ELECTRICAL CHARACTERISTICS

T_A = 25°C, unless otherwise noted

Parameter	Symbol	Conditions	Min	Typ	Max	Unit
Static Characteristics						
Drain-Source Breakdown Voltage	BV _{DSS}	V _{GS} =0V, I _{DS} =250μA	30	-	-	V
Zero Gate Voltage Drain Current	I _{DSS}	V _{DS} =24V, V _{GS} =0V	-	-	1	μA
		T _J =85°C	-	-	30	
Gate Threshold Voltage	V _{GS(th)}	V _{DS} =V _{GS} , I _{DS} =250μA	1.3	1.8	2.5	V
Gate Leakage Current	I _{GSS}	V _{GS} =±20V, V _{DS} =0V	-	-	±100	nA
Drain-Source On-state Resistance	R _{DS(ON)} NOTE2	V _{GS} =10V, I _{DS} =8A	-	14	17	mΩ
		V _{GS} =4.5V, I _{DS} =5A	-	16.5	21.5	
Diode Characteristics						
Diode Forward Voltage	V _{SD} NOTE2	I _{SD} =1A, V _{GS} =0V	-	0.73	1.1	V
Reverse Recovery Time	t _{rr} NOTE3	I _{SD} =8A, dI _{SD} /dt=100A/μs	-	15	-	ns
Reverse Recovery Charge	Q _{rr} NOTE3		-	4.2	-	nC
Dynamic Characteristics NOTE3						
Gate Resistance	R _G	V _{GS} =0V, V _{DS} =0V, F=1MHz	2	2.5	3.4	Ω
Input Capacitance	C _{iss}	V _{GS} =0V, V _{DS} =15V, Frequency=1.0MHz	630	760	910	pF
Output Capacitance	C _{oss}		105	125	145	
Reverse Transfer Capacitance	C _{rss}		57	72	87	
Turn-on Delay Time	t _{d(ON)}	V _{DD} =15V, R _L =15Ω, I _{DS} =1A, V _{GEN} =10V, R _G =6Ω	-	9	-	ns
Turn-on Rise Time	t _r		-	9	-	
Turn-off Delay Time	t _{d(OFF)}		-	24	-	
Turn-off Fall Time	t _f		-	5.5	-	
Gate Charge Characteristics NOTE3						
Total Gate Charge	Q _g	V _{DS} =15V, V _{GS} =4.5V, I _{DS} =8A	-	6	8	nC
Total Gate Charge	Q _g	V _{DS} =15V, V _{GS} =10V, I _{DS} =8A	-	14	17	
Threshold Gate Charge	Q _{gth}		-	1.3	1.6	
Gate-Source Charge	Q _{gs}		-	2.7	3.3	
Gate-Drain Charge	Q _{gd}		-	2.2	2.7	

NOTE2: Pulse test: pulse width ≤300μs, duty cycle ≤ 2%

NOTE3: Guaranteed by design, not subject to production testing.



TYPICAL CHARACTERISTICS

1. Power Dissipation

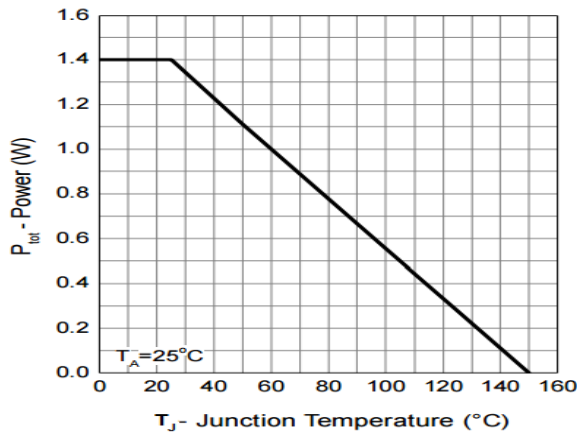

2. Drain Current

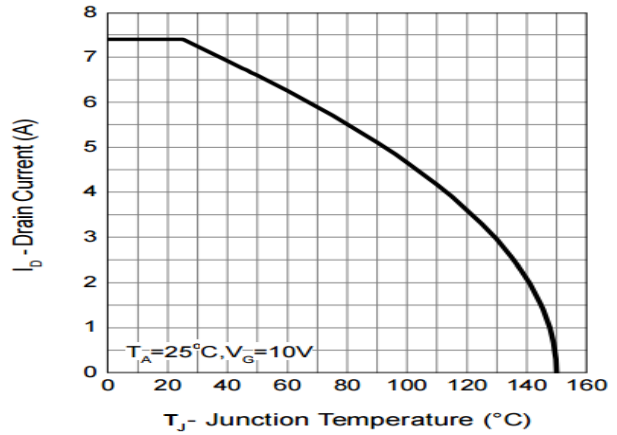

3. Safe Operation Area

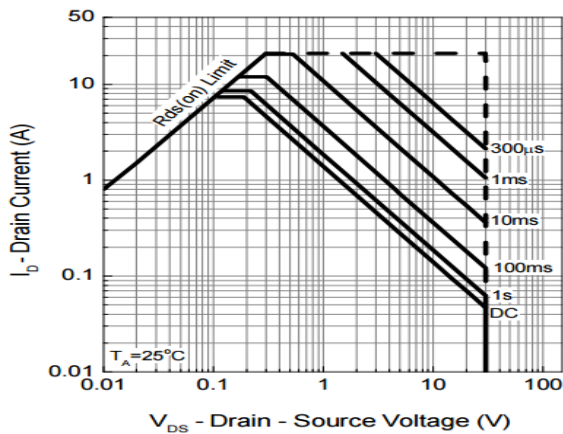

4. Thermal Transient Impedance

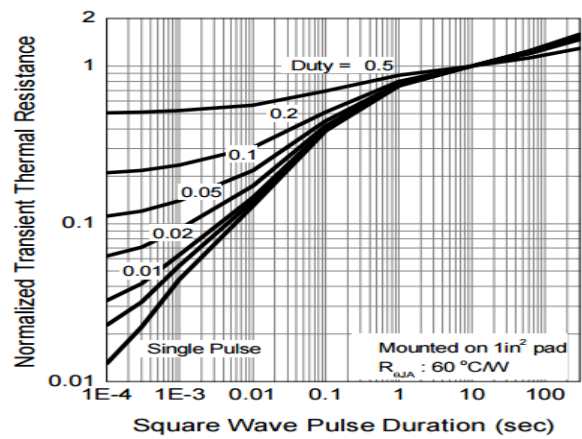

5. Output Characteristics

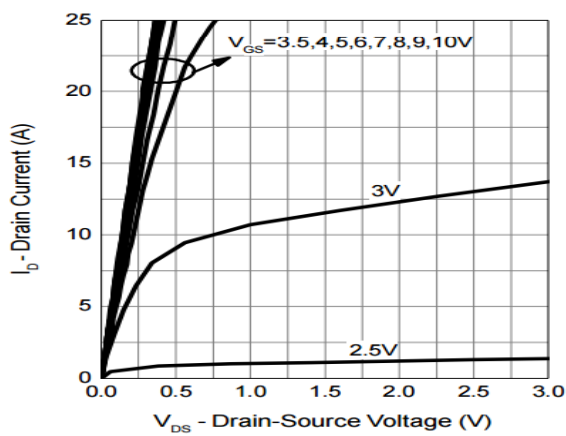

6. Drain-Source On Resistance

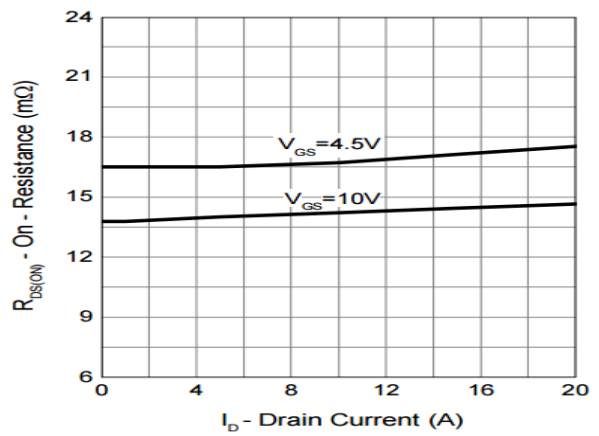



7. Gate-Source On Resistance

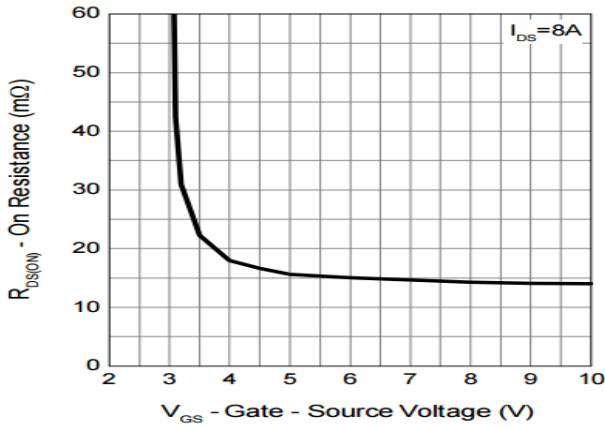

8. Gate Threshold Voltage

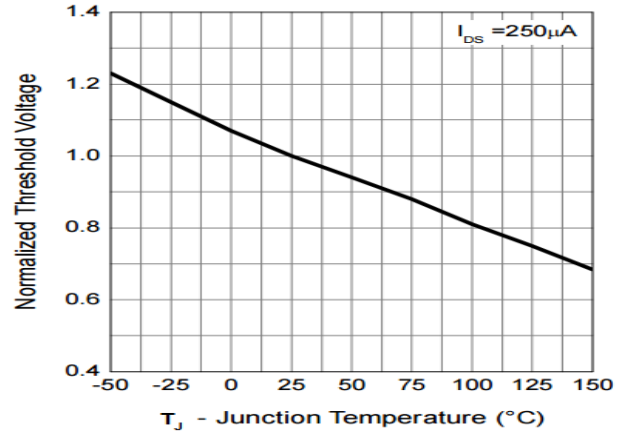

9. Drain-Source On Resistance

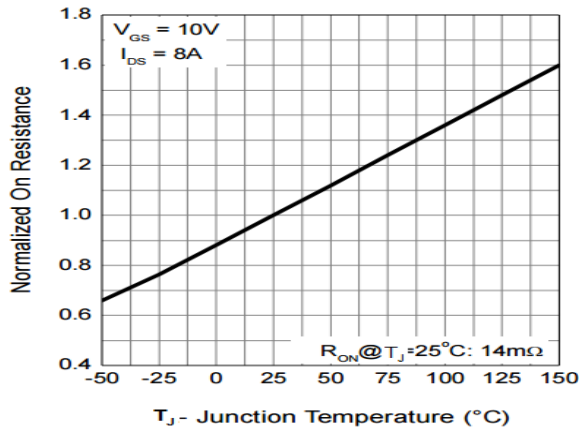

10. Source-Drain Diode Forward

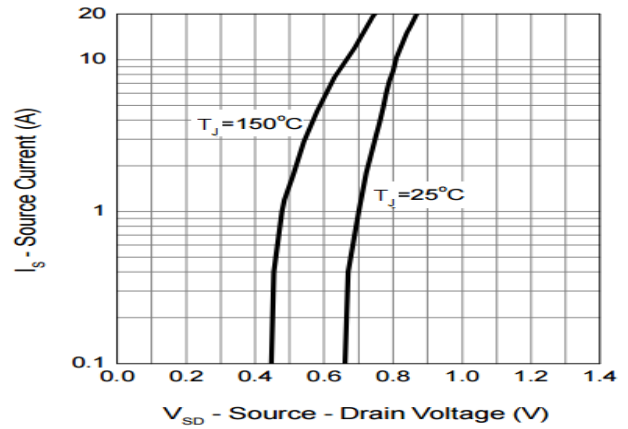

11. Capacitance

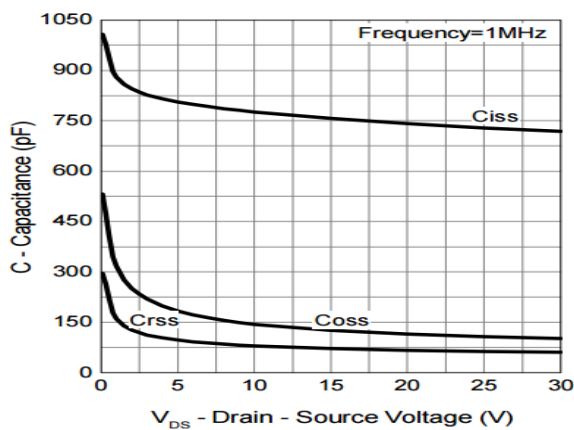

12. Gate Charge

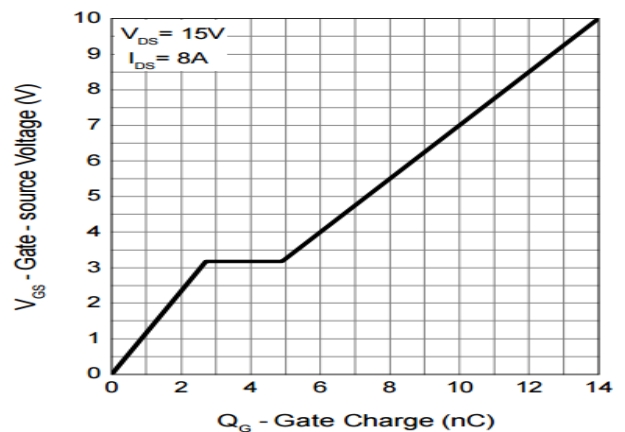



DETAILED INFORMATION

Avalanche Test Circuit and Waveforms

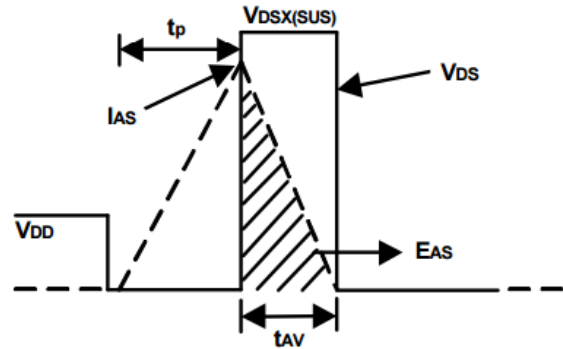
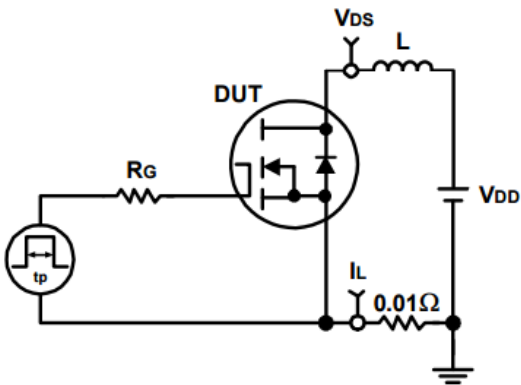

Switching Time Test Circuit and Waveforms

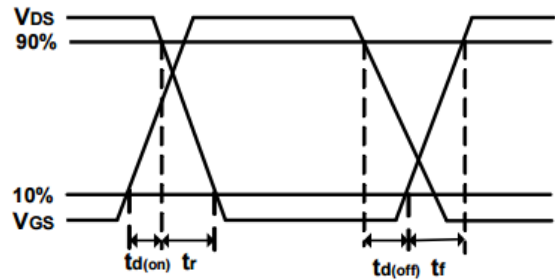
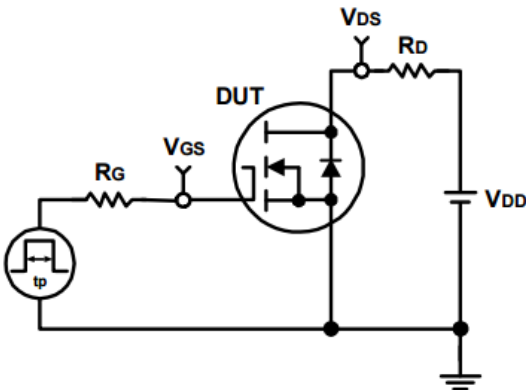



PACKAGE INFORMATION

Dimension in SOT-26 (Unit: mm)

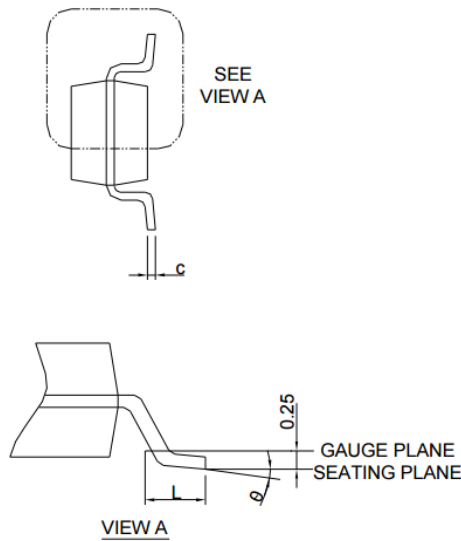
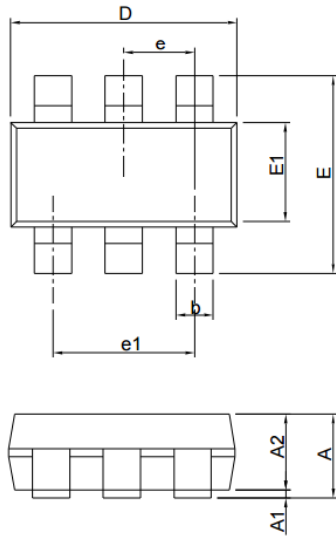

RECOMMENDED LAND PATTERN

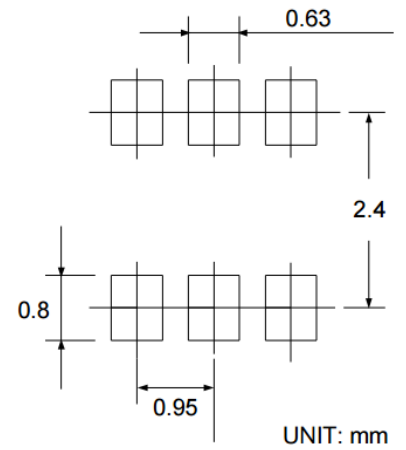

Symbol	Min	Max
A	-	1.250
A1	0.000	0.050
A2	0.900	1.200
b	0.300	0.500
c	0.080	0.220
D	2.700	3.100
E	2.600	3.000
E1	1.400	1.800
e	0.950 (BSC)	
e1	1.900 (BSC)	
L	0.300	0.600
θ	0°	8°



IMPORTANT NOTICE

AiT Semiconductor Inc. (AiT) reserves the right to make changes to any its product, specifications, to discontinue any integrated circuit product or service without notice, and advises its customers to obtain the latest version of relevant information to verify, before placing orders, that the information being relied on is current.

AiT Semiconductor Inc.'s integrated circuit products are not designed, intended, authorized, or warranted to be suitable for use in life support applications, devices or systems or other critical applications. Use of AiT products in such applications is understood to be fully at the risk of the customer. As used herein may involve potential risks of death, personal injury, or servers property, or environmental damage. In order to minimize risks associated with the customer's applications, the customer should provide adequate design and operating safeguards.

AiT Semiconductor Inc. assumes to no liability to customer product design or application support. AiT warrants the performance of its products of the specifications applicable at the time of sale.